

## MOUNTS AND ACCESSORIES FOR MARINE ANTENNAS

(ALL MOUNTS ARE THREADED 1"-14 TPI AS ARE SUITABLE FOR ALL BRANDS OF MARINE AND GPS ANTENNAS)

**RA 115**  
NYLON

4 way ratchet mount.  
8mm Hole for loran or GPS cable feed thru for coax cable and gasket, standard thread 1" x 14 for antennas max 8' (2.40 mts) weight 200 GRS

**RA 135**  
NYLON

Four way ratchet mount for installation on deck or bulkhead, locking by knob. Hole for loran or GPS cable. For antennas max 8' in self supporting installation built in feed - thru for coax cable. Standard thread 1" x 14, weight 140 grs.

**RA 116**  
BRASS

Ratchet mount polished chromed brass  
Four way for installation on deck or bulkhead, locking by handle. Hole for loran or GPS cable. The exclusive built-in feed-thru allows the passage of coax cable. Standard thread 1" x 14, weight 800 grs.

**RA 166**  
STAINLESS STEEL

Ratchet mount stainless steel. Four way ratchet mount for installation on deck or bulkhead, locking by knob. Hole for loran or GPS cable. For antennas max 8' in self supporting installation built in feed - thru for coax cable. Standard thread 1" x 14.

**RA 107**  
BRASS

Ratchet mount polished chromed brass  
Four way for installation on deck or bulkhead, locking by clamp. Hole for loran or GPS cable. The exclusive built in feed - thru allow the passage of coax cable. Standard thread 1" x 14, weight 550 grs.

**RA 101**  
NYLON

Set of 3 rectangular wedges for Glomex ratchet mount allows to keep the antenna vertical on the inclined surfaces.

**RA 134**  
NYLON

Pulpit rail swivel mount in reinf. nylon with knob hole for GPS cable for pulpits 22 and 25 mm. (7/8" and 1")

**RA 147**  
NYLON

Same as RA134, plus GPS extension 100 mm (4")

**RA 165**  
STAINLESS STEEL

Rail ratchet mount stainless steel. Ratchet design with hole for loran or GPS cable. Vertical or horizontal installation on rails of 7/8" (22 mm) and 1" (25 mm). Designed for antennas up to eight feet. Standard thread 1"x14.

**RA 125**  
NYLON

Reinforced nylon pulpit-rail mount 1" x 14 thread pre-drilled for loran cable - adaptable for tubes 1" or 7/8" (22 or 25mm)

**RA 145**  
NYLON

Reinforced nylon pulpit-rail mount 1" x 14 thread for GPS antennas only

**RA 147**  
NYLON

Same as RA134, plus GPS extension 100 mm (4")

**V9174**  
STAINLESS  
STEEL

Universal mount  
standard thread  
1"x14 height 100 mm  
(4")

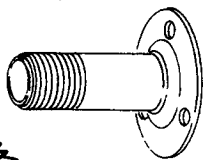

Thread 1" - 14

*Electropolished*

**V9175**  
NYLON

Universal mount for  
GPS antenna stan-  
dard thread 1"x14  
height 100 mm (4")

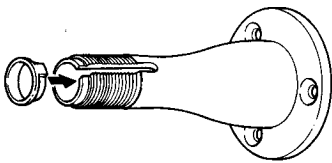

**RA 102**  
NYLON

Set of 2 round  
wedges for  
Glomex  
universal  
mounts V  
9175 - V 9174  
and  
V 9124 allow  
to keep the  
antenna  
vertical on the  
inclined  
surfaces.

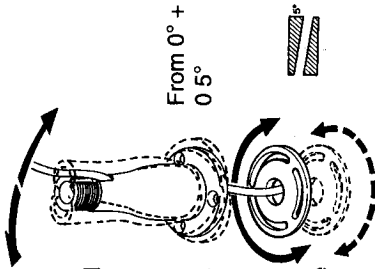

**V9101**



PVC gasket for  
aluminium surface  
insulation for  
V 9174 - V 9124

**RA138**  
PVC

PVC threaded  
protection for  
connectors



**RA140**  
NYLON

Four way nylon swivel  
base for plotters

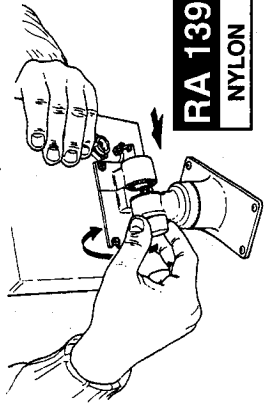
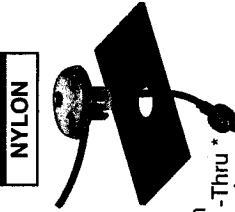

**RA 139**  
NYLON

**RA136**  
NYLON

Kit for installation  
of electronic chart  
plotters allows  
installation of the  
plotters on  
a vertical tube  
diam. 25 mm.  
(1") and 22 mm. (7/8").  
The plotter can be adjusted on the vertical and  
horizontal axis, when not used the mount can be  
folded by the swivel rail mount installed on the  
vertical tube.

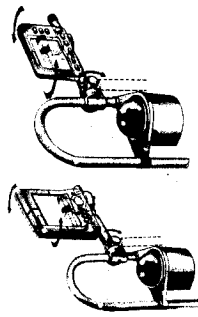

**RA119**  
NYLON

28 (1" 1/4)  
25 (1")

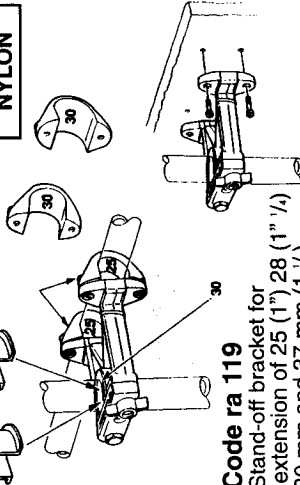

**Code ra 119**  
Stand-off bracket for  
extension of 25 (1" 1/4)  
30 mm and 37 mm (1 1/2")  
supplied with clamps for pulpits of 25  
(1") and 30mm and hardware

**V9176**  
STAINLESS  
STEEL

L Masthead  
bracket in  
electropoli-  
shed  
stainless  
steel  
Height 200  
mm. (8")  
standard  
thread  
1"x14

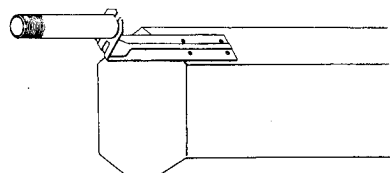

**V9171**  
STAINLESS  
STEEL

Pipe  
mounting  
bracket in  
stainless  
steel,  
thread  
1"x14.  
For  
horizontal  
and  
vertical  
mount.

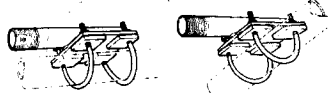

**V9173**  
STAINLESS  
STEEL

Masthead bracket  
in electropolished  
stainless steel  
Standard thread 1"  
x 14, weight 330  
grs.

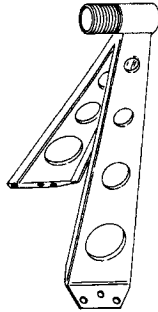

Nylon  
Feed - Thru \*  
For deck  
passage of  
one or two  
c o a x i a l  
cables and  
connectors  
(RG58  
or similar).  
Not sold  
in USA

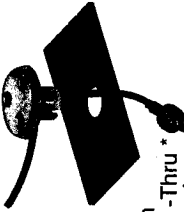

**STAINLESS STEEL EXTENSIONS**

- RA 123** 1,5 mts (5')
- RA 103** 150 mm (6)
- RA 103/30** 300 mm (12')
- RA 103/60** 600 mm (2')

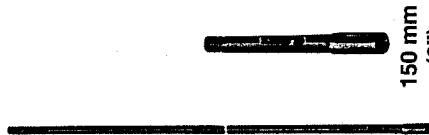

150 mm (6")

**FIBREGLASS EXTENSIONS**

- RA 120** 2 mts (6,5')
- RA 149** 1,20 mts (4')
- RA 150** 2,40 mts (8')
- RA 122/60** 0,6 mts (2')

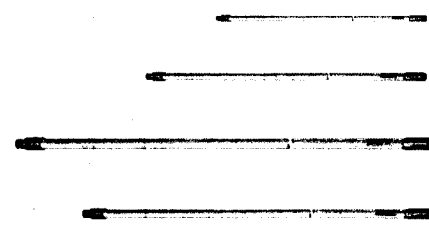

**GPS EXTENSIONS  
IN ALLUMINIUM EPOXY COATED**

- RA 129/15** 0,15 mts (6')
- RA 129/30** 0,3 mts (1')
- RA 129/60** 0,6 mts (2')
- RA 122/120** 1,20 mts (4')

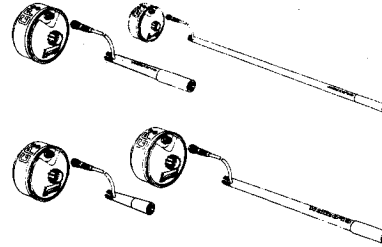

**RA137**  
NYLON

Kit for installation of electronic chart  
plotters allows installation of plotters  
on a horizontal tube diam. 25 mm. (1")  
and 22 mm. (7/8").  
The plotter can be adjusted on the  
horizontal axis by the ratchet lock up.

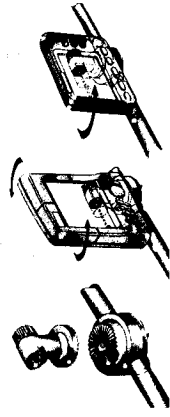

Via Braille, 12 - Zona Ind. - Fornace Zarattini - 48010 Ravenna - Italy  
Tel +39 544 500377 - Fax +39 544 500420  
e-mail glomex@netgate.it

**FAX OR E-MAIL US FOR A FREE FULL COLOURS CATALOGUE**